



# EnSky Managed Gigabit Switch Series

## Optimal Performance, Enterprise Features & Robust Management Options

EnSky Switch Series from EnGenius on-premise solution offers enterprise-level features, simplified network configuration, monitoring, and diversified management options with optimal performance for different scales of organizations.

For ease of deployment, this can be addressed by selecting 8, 24, or 48 Gigabit Power-over-Ethernet ready layer-2 switches with SFP and SFP+ Slots ports where the EnSky Managed Switch models also include desktop or rack mountable options with fanless or smart fan designs.

EnSky Managed Gigabit Switches are able to support easy deployment and hybrid operation mode; this will further allow swift installation and set-up to create a reliable, efficiently managed network from scratch.

## Features & Benefits

- Centrally manage wired & wireless networks via SkyKey or ezMaster
- The SkyKey can manage up to 100 EnGenius APs or Switches with built-in ezMaster software
- Manage up to 10,000 devices with ezMaster, which helps you to maintain multiple customer sites remotely
- 1G/2.5G/10G Base-T Ethernet ports
- A wide range of PoE/PoE+/PoE++ switches that support 802.3af/at/bt on all ports, supporting PoE budgets from 55W to 740W
- Up to Four SFP+ fiber ports with 1-Gigabit or 10-Gigabit speeds to extend connectivity via fiber uplinks, redundancy, and failover
- Advanced view displays network topology with devices and relationships
- Security: Access Control List/Port Security; 802.1X & RADIUS Authentication
- Advanced QoS with IPv4/IPv6 ingress traffic filtering (ACLs) & prioritization
- IGMP and MLD snooping provides advanced multicast filtering
- 802.3ad Link Aggregation (LACP) supports traffic load balancing
- Dual firmware images improves reliability & network uptime
- Advanced PoE features for Surveillance: PoE extended mode, PD lifeguard, and Continuous PoE power supply.

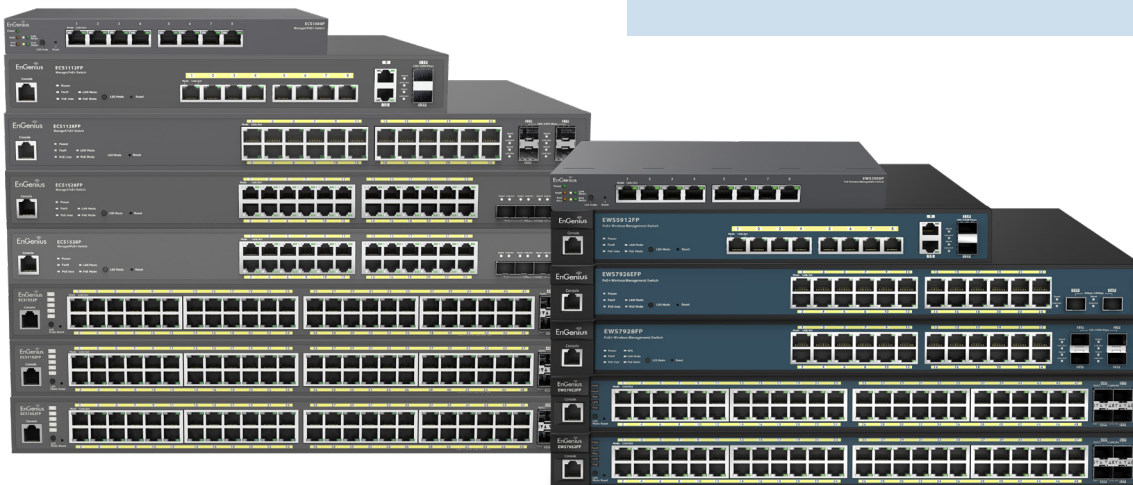

# Benefits to Help Grow Your Business

## High Performance up of 10-Gigabit Ethernet Capacity

The EnGenius EnSky Managed Switch Series provides 1G/2.5G/10G Base-T Ethernet ports that can transmit and receive data traffic without any loss. Capable of powering the performance of 802.11ax access points to support bandwidth larger than one gigabit per second, EnGenius switches provide faster overall network performance and deployment flexibility efficiently supporting both wired and wireless networks.

## SFP and SFP+ Slots for Flexible Deployments

The switch's SFP and SFP+ Slots options connect wired network segments throughout buildings extending beyond the limitations of Ethernet cabling. By reducing delays, businesses experience more consistent and uninterrupted communications.

## Maximum Power Supply Capabilities with 802.3bt

By providing a wide range of PoE/PoE+/PoE++ models that support 802.3af/803.at/802.3bt on all ports, companies can regulate power budgets according to device requirements and remotely power cycle individual ports, the 802.3bt standard of EnGenius switches delivers up to 60W of power to optimize the power management and longevity of your network devices, such as Wi-Fi 6 access points, outdoor surveillance cameras with heaters, and emerging power-hungry IoT devices.

## Advanced PoE Features Designing for Surveillance

The ECS1008P/ECS1112FP/ECS1528P/ECS1528FP/ECS1552P/ECS1552FP/ECS2528FP/ECS2552FP switches feature surveillance friendly functions to relieve the pain points of deployment and management for IP cameras. These advanced features are all based on the Power-over-Ethernet technology. The PoE extended mode allows you to deploy the camera over Ethernet cable at a more extended range up to 250\* meters. PD lifeguard real-time monitors the status of the camera and auto-reboot the camera when it is down. The continuous PoE power supplies the IP camera in operation without interruption of the switch rebooting during switch firmware upgrading.

## Increased Access Control and Security

Protect the network with 802.1X port-based client authentication with dynamic VLAN and security through a RADIUS server. Utilizing administrators can use Access Control Lists (ACLs) to see who has access to network segments while screening traffic from unauthorized MAC or IP addresses. By establishing a guest VLAN to grant and limit Internet resources for visitors, guests can use the network while also keeping the network secure.

## Improved VLAN/Voice and Quality of Service

Segment the network by departments or traffic types for increased performance and security with 802.1Q VLAN statically or dynamically. While 802.1p class of service prioritizes compliant VoIP and video traffic ensuring bandwidth intensive, time-sensitive data is forwarded immediately for clear, smooth voice and video delivery.

## On-Premises Management Platform

EnGenius EnSky's on-premises network management platform consists of SkyKey hardware and ezMaster management software. The platform empowers you to monitor, manage, and troubleshoot an indoor network locally or remotely. The plug-and-play SkyKey controller can manage up to 100 EnGenius access points or switches directly with built-in ezMaster software. ezMaster empowers you to setup and maintain multiple customer sites to save time and reduce the operational costs of site visits. You can manage up to 1,000 devices on a virtual machine server or 10,000 devices through AWS(Amazon Web Services).

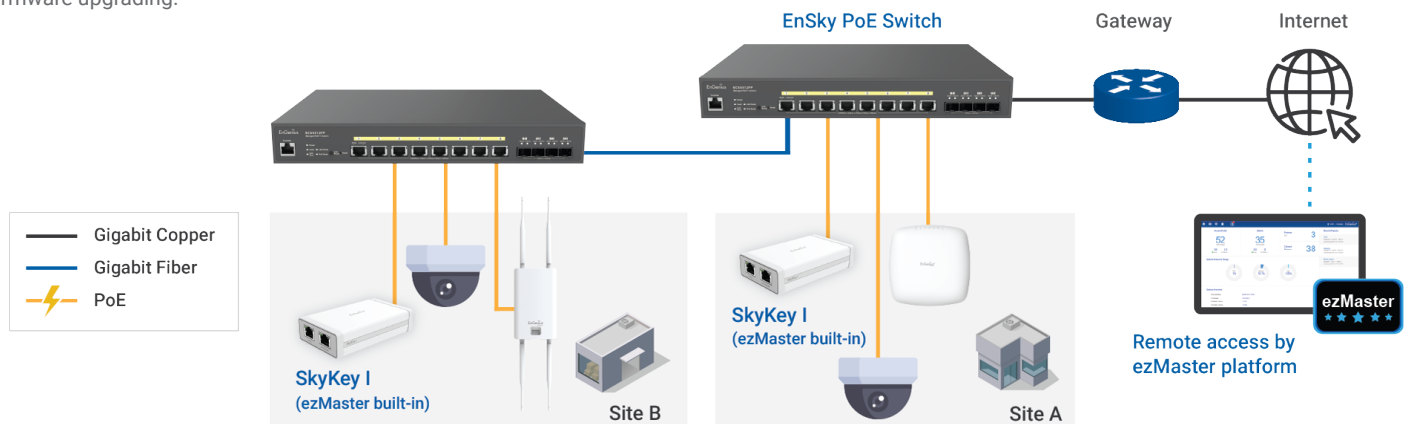

# Easy Network Management

## Network Traffic Management

EnSky Switches offer performance-enhancing features that reduce multicasting traffic, speed up port blocking and port forwarding, and increase bandwidth via load balancing. Control each port's available bandwidth speeds for connected devices like APs in areas where more or less speed is needed, such as in lobbies or conference rooms.

## In-Depth Network Visibility

The EnSky Switches achieve network management and visibility, network topology view automatically maps the network deployment to display device relationships across the infrastructure. It can monitor The network's performance by viewing port statistics, system logs, and RMON data and viewing wired and wireless traffic via a comprehensive at-a-glance dashboard and get rich analytics and reporting.

## Flexible Deployment

By using multiple methods to manage switches, EnGenius decreases administration time through remote management, visibility, and troubleshooting. Select the most effective management approach based on network architecture, administrative permissions, technical aptitude, or even budget.

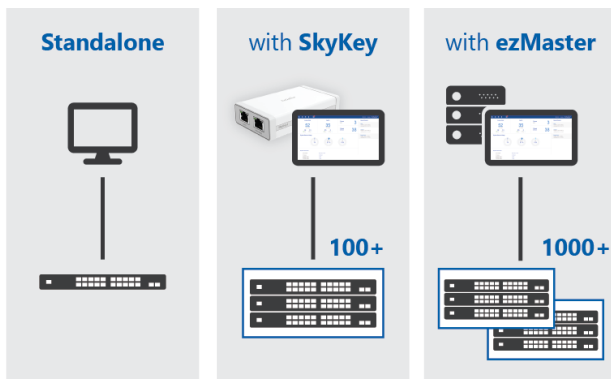

## Easy Monitoring & Troubleshooting

The EnSky on-premises management establishes the event based email alerts for notification of predetermined activities. It can and perform port diagnostics through ping tests and diagnose cable failure and trace the route data takes through the network to troubleshoot slowdowns or connection issues, that enabling troubleshoot issues without manual tracking, and access the management interface of other EnSky Switches directly from topology view with quick link.

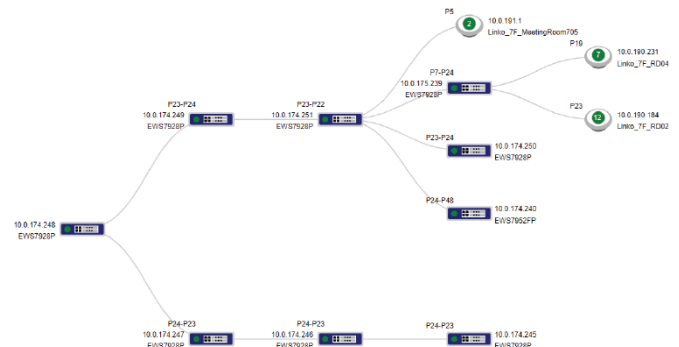

## Standalone Management

Each EnGenius EnSky Switch can be managed in a standalone setup from its intuitive user interface that provides full access into all the Layer 2 switching features.

## On-Premises Management with SkyKey

The EnSky solution can manage up to 100 EnGenius switches with the plug-and-play SkyKey controller, which provides on-premises and subscription-free remote access capability through EnGenius Cloud under single-pane-of-glass capabilities.

## On-Premises Management with ezMaster

Manage 1,000s of EnGenius switches with ezMaster network software, an on-premises solution utilizing a Virtual Machine server or a private-cloud AWS account that easily configures and maintains multiple customer sites and thousands of devices via ezMaster network management software, all with no license or subscription fees.

# Software Lists of Layer 2-Plus Managed Switches

## Layer 3 Features (ECS Switch supported only)

### Static Route

Static routes are manually configured by a network administrator to use the IPv4/IPv6 static route to view and configure the static and default route settings. Allow user to create 63 IPv4 static route and 21 IPv6 static route entries.

### Neighbor Discovery

Neighbor Discovery Protocol (NDP) is a function to detect whether IPv6 devices and addresses are duplicated. It is similar with the ARP table function in IPv4.

### IGMP

The Internet Group Management Protocol (IGMP) is a communications protocol used by hosts and adjacent routers on IPv4 networks to establish multicast group memberships. IGMP is an integral part of IP multicast. IGMP can be used for one-to-many networking applications such as online streaming video and gaming, and allows more efficient use of resources when supporting these types of applications. IGMP is used on IPv4 networks. Multicast management on IPv6 networks is handled by Multicast Listener Discovery (MLD) which is a part of ICMPv6 in contrast to IGMP's bare IP encapsulation.

### MLD

Multicast Listener Discovery (MLD) is a component of the Internet Protocol Version 6 (IPv6) suite. MLD protocol enables IPv6 routers to discover multicast listeners, the nodes that are configured to receive multicast data packets, on its directly attached interfaces. Much like Internet Group Management Protocol (IGMP) is used in IPv4.

### ARP Table

The Address Resolution Protocol (ARP) is a required function in IP routing. ARP finds the hardware address, also known as Media Access Control (MAC) address, of a host from its known IP address. ARP maintains a cache (table) in which MAC addresses are mapped to IP addresses.

### LBD (Loopback Detection)

Loopback Detection (LBD) is a feature on the switch that provides protection against loops by transmitting loop protocol packets out of ports where loop protection has been enabled. When the switch sends out a loop protocol packet and then receives the same packet, it shuts down the port that received the packet.

### Jumbo Frame

Jumbo frames are network-layer PDUs that have 10000 bytes larger enough to carry an 8 KB application datagram plus packet header overhead. It needs to be configured to work on the ingress and egress port of each device along the end-to-end transmission path.

### MAC Address Table

The MAC address table contains address information that the Switch uses to forward traffic between the inbound and outbound ports. All MAC addresses in the address table are associated with one or more ports.

### LLDP (Link Layer Discovery Protocol)

Link Layer Discovery Protocol (LLDP) is essentially a neighbor discovery protocol that uses Ethernet connectivity to advertise information to devices on the same LAN and store information about the network. This information allows the device to quickly identify a variety of other devices, resulting in a LAN that interoperates smoothly and efficiently.

### IGMP Snooping

Internet Group Management Protocol (IGMP) Snooping allows a Switch to forward multicast traffic intelligently. A Switch supporting IGMP Snooping can passively snoop on IGMP Query, Report, and Leave packets transferred between IP Multicast switches and IP Multicast hosts to determine the IP Multicast group membership.

### MLD Snooping

Multicast Listener Discovery (MLD) Snooping operates on the IPv6 traffic level for discovering multicast listeners on a directly attached port and performs a similar function to IGMP Snooping for IPv4. MLD Snooping limits IPv6 multicast traffic by dynamically configuring the Switch port so that multicast traffic is forwarded only to those ports that wish to receive it. This reduces the flooding of IPv6 multicast packets in the specified VLANs.

### Multicast Filtering

Multicast is a form of communication that allows multiple transmissions of multimedia and streaming data to specific recipients at the same time. Multicast Filtering feature lets you sort out selective multiple transmissions for

## Layer 2 Features

### DHCP Snooping (ECS Switch Supported)

DHCP snooping is a layer 2 security technology built into the operating system of a capable network switch that drops DHCP traffic determined to be unacceptable. The fundamental use case for DHCP snooping is to prevent unauthorized (rogue) DHCP servers offering IP addresses to DHCP clients.

### DHCP Relay (ECS Switch supported only)

A DHCP relay agent is any host that forwards DHCP packets between clients and servers. Relay agents are used to forward requests and replies between clients and servers when they are not on the same physical subnet.

### DHCP Option 82 (ECS Switch supported only)

DHCP option 82 provides additional security when DHCP is used to allocate network addresses. It enables the switch to act as a DHCP relay agent to prevent DHCP client requests from untrusted sources.

### PoE (Power over Ethernet)

Power over Ethernet (POE) is a technology that lets network cables carry electrical power. POE switch is a network switch that has Power over Ethernet injection built-in. Simply connect other network devices to the switch as normal, and the switch will detect whether they are POE-compatible and enable power automatically.

### EEE (Energy Efficient Ethernet)

Energy Efficient Ethernet (EEE) reduces the power consumption of physical layer devices during periods of low link utilization. EEE saves energy by allowing PHY non-essential circuits shut down when there is no traffic.

### Link Aggregation

A Link Aggregation Group (LAG) optimizes port usage by linking a group of ports together to form a single, logical, higher-bandwidth link. Aggregating ports multiplies the bandwidth and increases port flexibility for the Switch.

### STP (Spanning Tree Protocol)

The Spanning Tree Protocol (STP) can be used to detect and disable network loops, and to provide backup links between Switches.

## VLAN Features

### 802.1Q VLAN

A Virtual LAN (VLAN) is a group of ports that form a logical Ethernet segment on a Layer 2 Switch which provides better administration, security, and management of multicast traffic. A VLAN is a network topology configured according to a logical scheme rather than a physical layout. When you use a VLAN, users can be grouped by logical function instead of physical location.

### PVID (Port VLAN ID)

When an untagged packet enters a Switch port, the PVID (Port VLAN ID) will be attached to the untagged packet and forward frames to a VLAN specified VID part of the PVID. A packet received on a given port would be assigned that port's PVID and then be forwarded to the port that corresponded to the packet's destination address.

### Voice VLAN

Enhance your Voice over IP (VoIP) service by configuring ports to carry IP voice traffic from IP phones on a specific VLAN. Voice VLAN provides QoS to VoIP, ensuring that the quality of the call does not deteriorate if the IP traffic is received erratically or unevenly.

# Software Lists of Layer 2-Plus Managed Switches

## VLAN Features

### MAC based VLAN\*

The MAC-based VLAN feature allows incoming untagged packets to be assigned to a VLAN and thus classify traffic based on the source MAC address of the packet. You define a MAC to VLAN mapping by configuring an entry in the MAC to VLAN table. An entry is specified using a source MAC address and the appropriate VLAN ID. The MAC to VLAN configurations are shared across all ports of the device.

### Protocol VLAN\*

A protocol-based VLAN processes traffic based on protocol. You can use a protocol-based VLAN to define filtering criteria for untagged packets. The smart switch always processes tagged packets according to the 802.1q standard and does not forward them to protocol-based VLANs.

### VTP advertisement (ECS Switch supported only)

VLAN Trunk Protocol (VTP) reduces administration in a switched network. Once the VLAN Trunking Protocol (VTP) is configured on the switches, the switches start advertising VLAN Trunking Protocol (VTP) information between them on their trunk ports. This reduces the need to configure the same VLAN everywhere.

### Dynamic VLAN assignment (ECS Switch supported only)

Dynamic VLAN assignment are used by network admins/engineers to place a wireless user into a specific VLAN based on the credentials supplied by the user. This task of assigning users to a specific VLAN is handled by a RADIUS authentication server. Users in an organization are then segmented into these dynamic VLANs based on the resources they can access.

\* Available through future firmware upgrade.

## Quality of Service

### Quality of Service

Quality of Service (QoS) provides the ability to implement priority queuing within a network. In a Switch, multiple queues per port are often provided to give preference to certain packets over others based on user-defined criteria. When a packet is queued for transmission within a port, the rate at which it is processed depends on how the queue is configured and the amount of traffic present within other queues on the port. If a delay is necessary, packets are held in the queue until they are authorized for transmission.

### Class of Service (CoS)

Class of service is a parameter used in data and voice protocols to differentiate the types of payloads contained in the packet being transmitted. The objective of such differentiation is generally associated with assigning priorities to the data payload or access levels to the telephone call.

### CoS Mapping

Use the Class of Service (CoS) Mapping feature to specify which internal traffic class to map to the corresponding CoS value. CoS allows you to specify which data packets have greater precedence when traffic is buffered due to congestion.

### Differentiated Services Code Point (DSCP)

Differentiated services or DiffServ is a computer networking architecture that specifies a simple and scalable mechanism for classifying and managing network traffic and providing quality of service (QoS) on modern IP networks. Use Differentiated Services Code Point (DSCP) Mapping feature to specify which internal traffic class to map to the corresponding DSCP values. DSCP Mapping increases the number of definable priority levels by reallocating bits of an IP packet for prioritization purposes.

### Weighted Round-Robin (WRR)

Weighted round robin (WRR) is a network scheduling discipline. Each packet flow or connection has its own packet queue in a network interface controller. In WRR mode the number of packets sent from the queue is proportional to the weight of the queue (the higher the weight the more frames are sent).

### Bandwidth Management

Bandwidth management is the process of measuring and controlling the communications (traffic, packets) on a network link, to avoid filling the link to capacity or overflowing the link, which would result in network congestion and poor performance of the network. Bandwidth is measured in bits per second (bit/s) or bytes per second (B/s).

## Security

### Radius Server

RADIUS proxy servers are used for centralized administration. Remote Authentication Dial In User Service (RADIUS) is a networking protocol that provides centralized Authentication, Authorization, and Accounting (AAA) management for users that connect and use a network service for greater convenience.

### 802.1X Authentication Protocol

IEEE 802.1X is an IEEE Standard for port-based Network Access Control (PNAC). It is part of the IEEE 802.1 group of networking protocols. It provides an authentication mechanism to devices wishing to attach to a LAN or WLAN.

### 802.1x Port-based Access Control

The IEEE 802.1X port-based authentication provides a security standard for network access control with RADIUS servers and holds a network port disconnected until authentication is completed. With 802.1X port-based authentication, the supplicant provides the required credentials, such as user name, password, or digital certificate to the authenticator, and the authenticator forwards the credentials to the authentication server for verification to the guest VLAN.

### MAC-Based Port Security (MAC-based Access Control)

Network security can be increased by limiting access on a specific port to users with specific MAC addresses. Port Security prevents unauthorized device to the Switch prior to stopping auto-learning processing.

### Authenticated Host

The Authenticated Host displays the Authenticated User Name, Port, Session Time, Authenticated Method, and Mac Address.

### Guest VLAN

A Guest VLAN is a VLAN that allows guests to get in the network. For example, employees and guests can access the wireless network of a company at the same time and be administratively separate.

### VLAN Tag

Independent VLAN setting can be enable or disable. Any packet that enters the Device without a VLAN tag will have a VLAN tag inserted with a PVID (Ethernet Port VID).

### Radius VLAN Assignment (ECS Switch supported only)

VLAN assignments build on the use of RADIUS to control access to the network. Via RADIUS integration, a WiFi access point (WAP) requires not only an SSID and passphrase, but a user's unique set of credentials to access the network. Once a user has passed credentials through to the WAP and they are subsequently passed to the RADIUS server and directory service, the RADIUS server will reply to the WAP that the user has been authenticated and inform what VLAN they are assigned to.

### Management VLAN

Feature is enabled with specified VLAN ID, the device will only allow management access with the same specified VLAN ID from remotely location by using protocols such as telnet, SSH, snmp, syslog etc.

### Storm Control

Storm Control limits the amount of Broadcast, Unknown Multicast, and Unknown Unicast frames accepted and forwarded by the Switch. Storm Control can be enabled per port by defining the packet type and the rate that the packets are transmitted at.

### Port Isolation

Port Isolation feature provides L2 isolation between ports within the same broadcast domain. When enabled, isolated ports can forward traffic to Not Isolated ports, but not to other isolated ports. Not Isolated ports can send traffic to any port; whether Isolated or Not Isolated.

### DoS Attack Prevention

Denial of Service attack is an attack on the computer or network that restricts, reduce or prevents system restore accessibility to its legitimate users. It is a kind of attack in which an attacker or intruder tries to deprive system users or authorized users of accessing their computers, networks or sites. Enable DoS Attack prevention feature to classifying and blocking specific types of DoS attacks.

# Software Lists of Layer 2-Plus Managed Switches

## Security

### Access Control List

An Access Control List (ACL) allows you to define classification rules or establish criteria to provide security to your network by blocking unauthorized users and allowing authorized users to access specific areas or resources. ACLs can provide basic security for access to the network by controlling whether packets are forwarded or blocked at the Switch ports.

### Login Authentication Control

Support SSH/Telnet command or HTTP/HTTPS login methods

## Management

### Account Multi-Privileges Management

Enable this function to control management access to the Switch based on manually configured user names and passwords. A User account can only view settings without the right to configure the Switch, and an Admin account can configure all the functions of the Switch.

### HTTPS

A secure communication protocol can be enabled to allow secure management web access over a computer network.

### SSH Tunnel

A secure communication protocol can be enabled to allow secure remote shell access or command execution.

### Command Line Interface (CLI)

CLI protocol provides the basic rules for making it possible to link a client to a command interpreter. The Telnet service for the Switch is enabled by default. For secure communication, it is better to use SSH over Telnet.

### SNMP & MIB

v1/v2c/v3 support  
MIB I/II, Private MIB  
CLI supported

### Remote Network Monitoring (RMON)

Remote Monitoring (RMON) is a standard monitoring specification that enables various network monitors and console systems to exchange network-monitoring data. RMON provides network administrators with more freedom in selecting network-monitoring probes and consoles with features that meet their particular networking needs.

### PoE Management

The PoE Management function support Power on/off per port, Power class configuration, Power feeding priority adjustment feature to monitoring the current power usage and assigns the total amount of power the Switch can provide to all of its PoE ports.

### PoE LifeGuard\* (ECS switch supported)

The switch can detect and monitor connected PoE IP cameras or PoE PD (Powered Device) status in real time. Once the PoE PD stops working and responding, switch will recover failed PoE PD device automatically. The PoE lifeguard function with customizable parameters enhance the reliability and suitable for any types of application scenarios.

### PoE Continuous Power\* (ECS switch supported)

Delivers nonstop PoE power to keep PoE IP cameras in operation, even if switch under maintenance for firmware updates, significantly reducing IP camera reboot time.

### Port Mirroring

Use port mirroring to send traffic to applications that analyze traffic for purposes such as monitoring compliance, detecting intrusions, monitoring and predicting traffic patterns, and other correlating events.

### Syslog

The Syslog protocol allows devices to send event notification messages in response to events, faults, or errors occurring on the platform as well as changes in configuration or other occurrences across an IP network to syslog servers.

### Ping

The Packet Internet Groper (Ping) test allows you to verify connectivity to remote hosts. The Ping test operates by sending Internet Control Message Protocol (ICMP) request packets to the tested host and waits for an ICMP response.

### Trace Route

The trace route feature is used to discover the routes that packets take when traveling to their destination. It will list all the routers it passes through until it reaches its destination, or fails to reach the destination and is discarded.

### Cable Diagnostics

Cable Diagnostics helps you to detect whether your cable has connectivity problems provides information about where errors have occurred in the cable.

### Dual Image

The Switch maintains two versions of the Switch image in its permanent storage. One image is the active image, and the second image is the backup image. The Dual Image screen enables the user to select which partition will be set as active after the next reset. The Switch boots and runs from the active image. If the active image is corrupt, the system automatically boots from the non-active image.

### Firmware Update

Update switch throughout manually update  
Update switch throughout one-click-update function

### Configuration Backup/Restore





Backup overall setting of the switch. Users can restore this settings/configuration to one switch easily.

### Reboot/Reset

Select to reboot or reset your switch under your application platform.

\*Available through future software upgrade.





# Switches Comparison Table

Wireless Controller Switches				
				
Model	EWS2908P	EWS2910P	EWS5912FP	EWS7928P
Switching Class	Layer 2	Layer 2	Layer 2	Layer 2
OS version	SNOS 1.0	SNOS 1.0	SNOS 1.0	SNOS 1.0
Wireless Controller	●	●	●	●
ezMaster managed mode	●	●	●	●
Standalone Switch	●	●	●	●
Gigabit Ethernet Ports	8	8	10	24
SFP Ports	-	2	2	4
SFP+ Ports	-	-	-	-
RJ45 Console Port	k5	-	1	1
PoE Standard	802.3af	802.3af	802.3af/at	802.3af/at
PoE Capable Ports	Ports 1-8	Ports 1-8	Ports 1-8	Ports 1-24
Maximum PoE Budget	55W	55W	130W	240W
Switching Capacity (Gbps)	16Gbps	20Gbps	24Gbps	56Gbps
Full load Power consumption	62.05 Watts	63.18 Watts	152.8 Watts	304.59 Watts
Packet Buffer memory	512KB	512KB	512KB	512KB
Max. Packet Forwarding Rate (Mpps)	11.9Mpps	14.88Mpps	17.856Mpps	17.856Mpps
MAC Address Table Size	8K	8K	8K	8K
Jumbo frame size	9K	9K	9K	9K
Weight	0.6 kg	0.6 kg	1.9 kg	3.6 kg
Dimension	240mm x 105mm x 27mm	240mm x 105mm x 27mm	330mm x 230mm x 44mm	440mm x 260mm x 44mm
Operating Temp.	0 to 40°C	0 to 40°C	0 to 50°C	0 to 50°C
Storage Temp.	-20 to 70°C	-20 to 70°C	-20 to 70°C	-20 to 70°C
Humidity	5% ~ 95%	5% ~ 95%	5% ~ 95%	5% ~ 95%

\*PoE Extended mode excels in long-range installation, but the actual performance may be affected by Ethernet cable quality or IP camera's electrical design. We suggested end-users to have an interoperability test before physical deployment.

\*Models vary depending on the region.

# Switches Comparison Table









Wireless Controller Switches				
				
Model	EWS1200-28TFP	EWS7926EFP	EWS7952P	EWS7952FP
Switching Class	Layer 2	Layer 2	Layer 2	Layer 2
OS version	SNOS 1.0	SNOS 1.0	SNOS 1.0	SNOS 1.0
Wireless Controller	●	●	●	●
ezMaster managed mode	●	●	●	●
Standalone Switch	●	●	●	●
Gigabit Ethernet Ports	24	24	48	48
SFP Ports	4	-	4	4
SFP+ Ports	-	2	-	-
RJ45 Console Port	1	1	1	1
PoE Standard	802.3af/at	802.3af/at	802.3af/at	802.3af/at
PoE Capable Ports	Ports 1-24	Ports 1-24	Ports 1-48	Ports 1-48
Maximum PoE Budget	410W	410W	410W	740W
Switching Capacity (Gbps)	56Gbps	88Gbps	104Gbps	104Gbps
Full load Power consumption	500.46 Watts	511.8 Watts	500.46 Watts	868.99 Watts
Packet Buffer memory	512KB	1.5MB	1.5MB	1.5MB
Max. Packet Forwarding Rate (Mpps)	41.664Mpps	65.472Mpps	77.376Mpps	77.376Mpps
MAC Address Table Size	8K	16K	16K	16K
Jumbo frame size	9K	12K	9K	9K
Weight	3.8 kg	3.8 kg	6.4 kg	6.4 kg
Dimension	440mm x 260mm x 44mm	440mm x 260mm x 44mm	440mm x 410mm x 44mm	440mm x 410mm x 44mm
Operating Temp.	0 to 50°C	0 to 50°C	0 to 50°C	0 to 50°C
Storage Temp.	-20 to 70°C	-20 to 70°C	-20 to 70°C	-20 to 70°C
Humidity	5% ~ 95%	5% ~ 95%	5% ~ 95%	5% ~ 95%

\*PoE Extended mode excels in long-range installation, but the actual performance may be affected by Ethernet cable quality or IP camera's electrical design. We suggested end-users to have an interoperability test before physical deployment.

\*Models vary depending on the region.









# Switches Comparison Table

Cloud-Enabled Switches								
Gigabit Switch								
								
Model	ECS1008P	ECS1112FP	ECS1528	ECS1528P	ECS1528FP	ECS1552	ECS1552P	ECS1552FP
Switch Class	Layer 2+	Layer 2+	Layer 2+	Layer 2+	Layer 2+	Layer 2+	Layer 2+	Layer 2+
Gigabit Ethernet Ports	8	10	24	24	24	48	48	48
Multi-Gigabit Ethernet Ports	-	-	-	-	-	-	-	-
SFP Ports	-	2	-	-	-	-	-	-
SFP+ Ports	-	-	4	4	4	4	4	4
RJ45 Console Port	-	●	●	●	●	●	●	●
Form Factor	9.45" (desktop)	13" 1U	19" 1U	19" 1U	19" 1U	19" 1U	19" 1U	19" 1U
Power-over-Ethernet	802.3af	802.3af/at	-	802.3af/at	802.3af/at	-	802.3af/at	802.3af/at
Total PoE Budget	55W	130W	-	240w	410w	-	410w	740w
PoE Capable Ports	Ports 1-8	Ports 1-8	-	Ports 1-24	Ports 1-24	-	Ports 1-48	Ports 1-48
Switching Capacity	16Gbps	24Gbps	128Gbps	128Gbps	128Gbps	176Gbps	176Gbps	176Gbps
Packet Forwarding Rate (Mpps)	11.904Mpps	17.856Mpps	95.23Mpps	95.23Mpps	95.23Mpps	130.95Mpps	130.95Mpps	130.95Mpps
MAC Address Table	8K	8K	16K	16K	16K	32K	32K	32K
Packet Buffer Memory	512KB	512KB	1.5MB	1.5MB	1.5MB	2MB	2MB	2MB
Full load Power consumption	62.05 Watts	152.8 Watts	24.41 Watts	297.6 Watts	500.46 Watts	43.92 Watts	476.3 Watts	885 Watts
*PoE Extended Mode	●	●	-	●	●	-	●	●
PD Lifeguard	●	●	-	●	●	-	●	●
Continuous PoE Power	●	●	-	●	●	-	●	●
Dimension	240mm x 105mm x 27mm	330mm x 230mm x 44mm	440mm x 200mm x 44mm	440mm x 260mm x 44mm	440mm x 260mm x 44mm	440mm x 260mm x 44mm	440mm x 310mm x 44mm	440mm x 310mm x 44mm

\*PoE Extended mode excels in long-range installation, but the actual performance may be affected by Ethernet cable quality or IP camera's electrical design. We suggested end-users to have an interoperability test before physical deployment.

\*Models vary depending on the region.

# Switches Comparison Table

Cloud-Enabled Switches						
Multi-Gigabit Switches						
						
Model	ECS2512	ECS2512FP	ECS2528FP	ECS2552FP	ECS5512	ECS5512FP
Switch Class	Layer 2+	Layer 2+	Layer 2+	Layer 2+	Layer 2+	Layer 2+
Gigabit Ethernet Ports	-	-	16	32	-	-
Multi-Gigabit Ethernet Ports	8x2.5G	8x2.5G	8x2.5G	16x2.5G	8 x 10G	8 x 10G
SFP Ports	-	-	-	-	-	-
SFP+ Ports	4	4	4	4	4	4
RJ45 Console Port	●	●	●	●	●	●
Form Factor	13" 1U	13" 1U	19" 1U	19" 1U	13" 1U	13" 1U
Power-over-Ethernet	-	802.3af/at/bt	802.3af/at	802.3af/at	-	802.3af/at/bt
Total PoE Budget	-	240w	410w	740w	-	420w
PoE Capable Ports	-	Ports 1-8	Ports 1-24	Ports 1-48	-	Ports 1-8
Switching Capacity	120Gbps	120Gbps	152Gbps	224Gbps	240Gbps	240Gbps
Packet Forwarding Rate (Mpps)	89.29 Mpps	89.29 Mpps	113.10 Mpps	166.67 Mpps	178.57 Mpps	178.57 Mpps
MAC Address Table	16k	16k	16k	32k	32k	32k
Packet Buffer Memory	512KB	512KB	1.5MB	2MB	2MB	2MB
Full load Power consumption	23.52 Watts	299 Watts	499.85 Watts	913 Watts	29.22 Watts	506.7 Watts
*PoE Extended Mode	-	-	●	●	-	-
PD Lifeguard	-	-	●	●	-	-
Continuous PoE Power	-	-	●	●	-	-
Dimension	330mm x 230mm x 44mm	330mm x 230mm x 44mm	440mm x 260mm x 44mm	440mm x 310mm x 44mm	330mm x 230mm x 44mm	330mm x 230mm x 44mm

\*PoE Extended mode excels in long-range installation, but the actual performance may be affected by Ethernet cable quality or IP camera's electrical design. We suggested end-users to have an interoperability test before physical deployment.

\*Models vary depending on the region.

# Technical Product Views

## Wireless Controller Switches

### EWS2908P

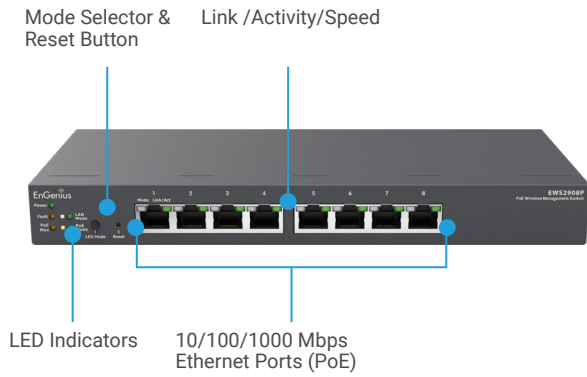

### EWS2910P

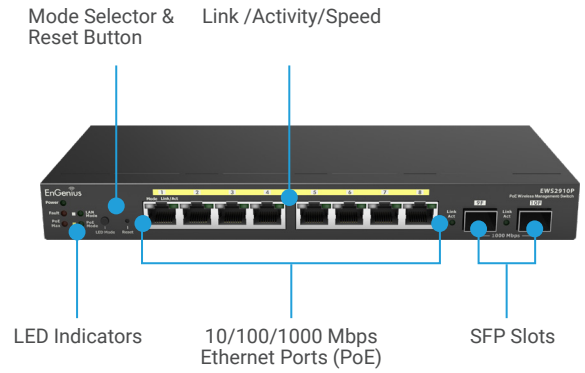

### EWS5912FP

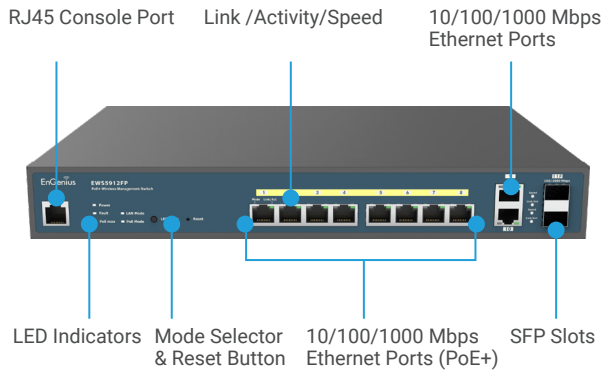

### EWS7928P

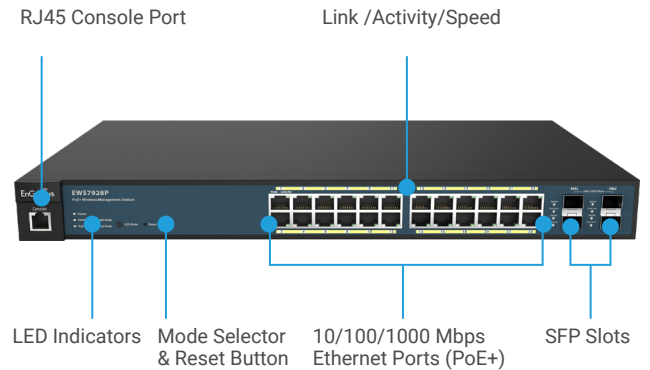

### EWS1200-28TFP

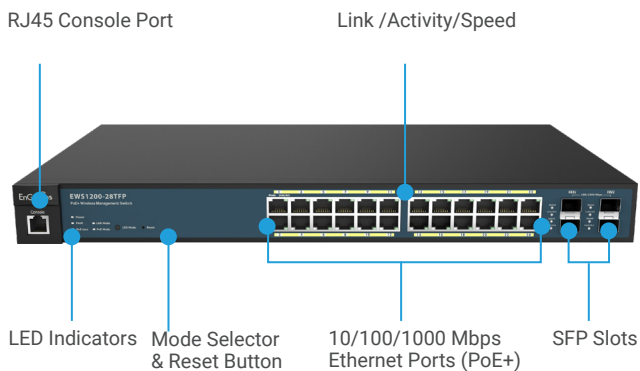

### EWS7926EFP

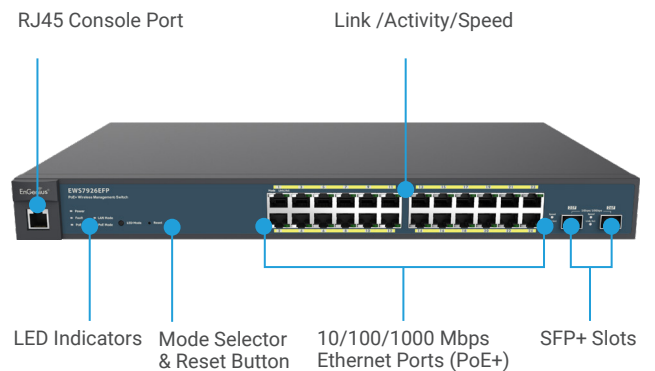

# Technical Product Views

## Wireless Controller Switches

### EWS7952P

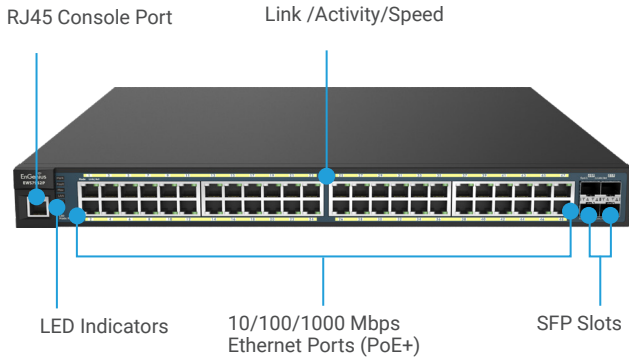

### EWS7952FP

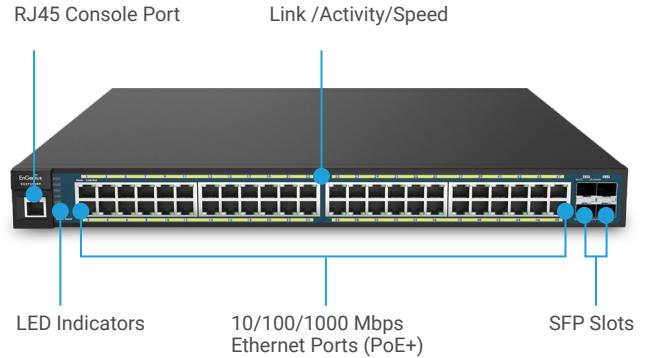

## Cloud-enabled Switches

### ECS1008P

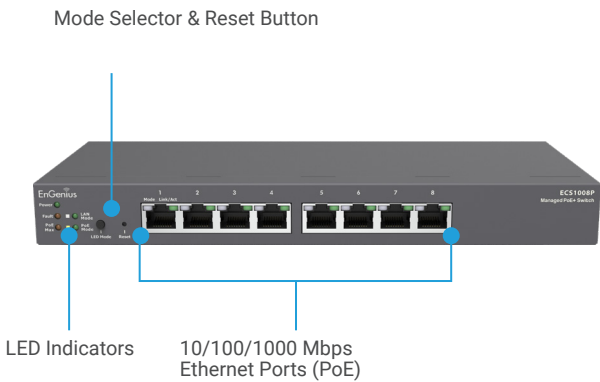

### ECS1112FP

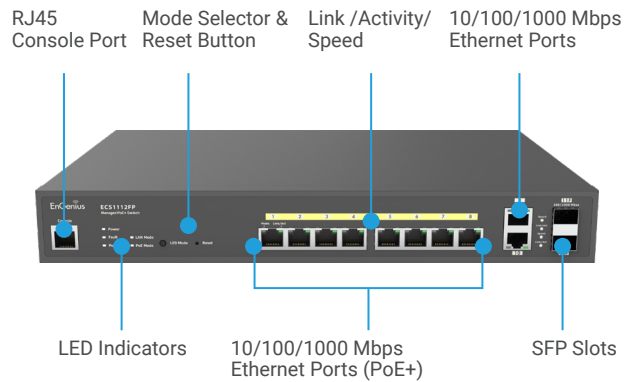

### ECS1528

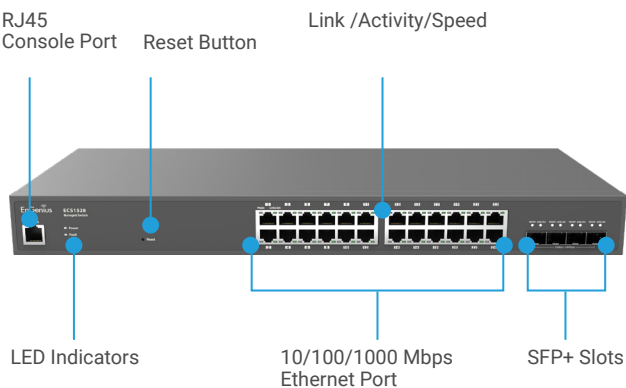

### ECS1528P

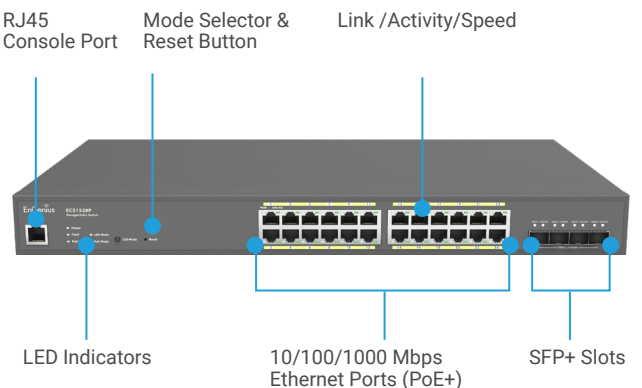

# Technical Product Views

## Cloud-enabled Switches

### ECS1528FP

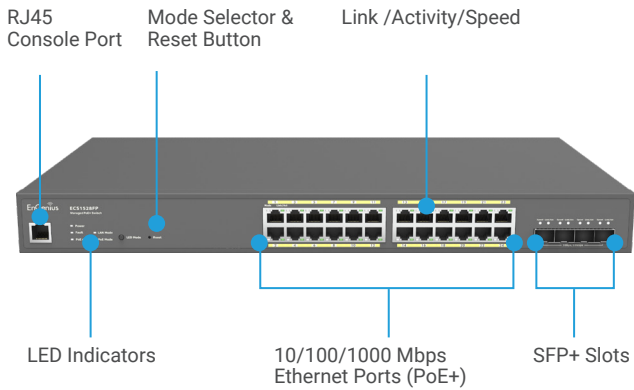

### ECS1552

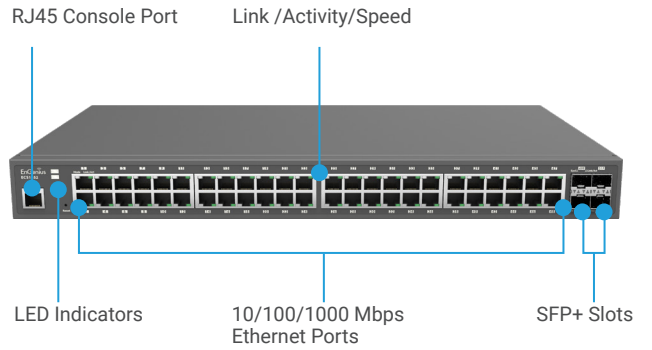

### ECS1552P

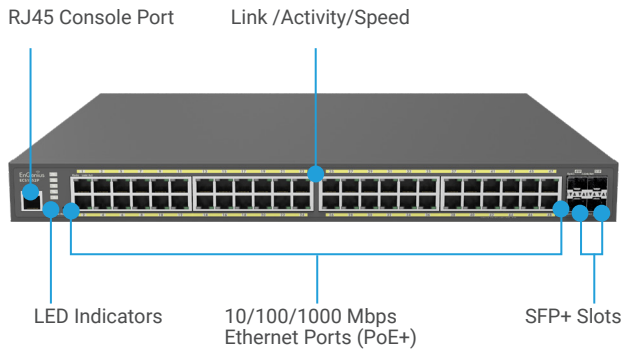

### ECS1552FP

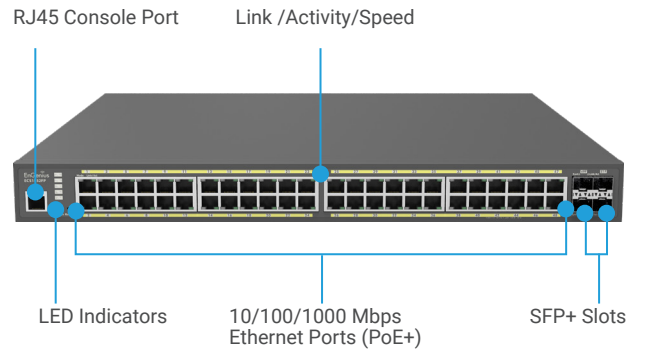

### ECS2512

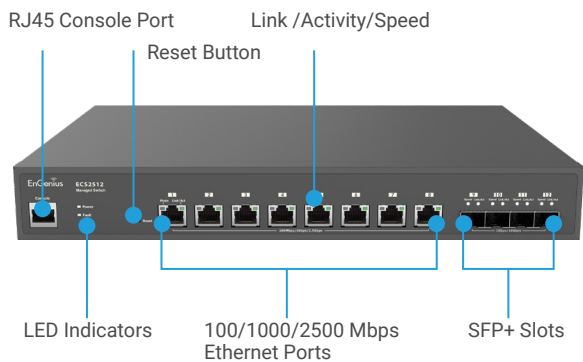

### ECS2512FP

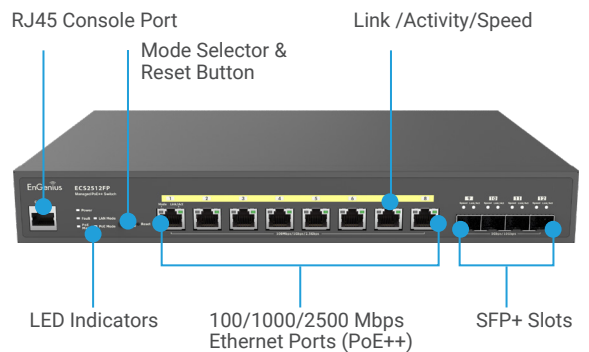

# Technical Product Views

## Cloud-enabled Switches

### ECS2528FP

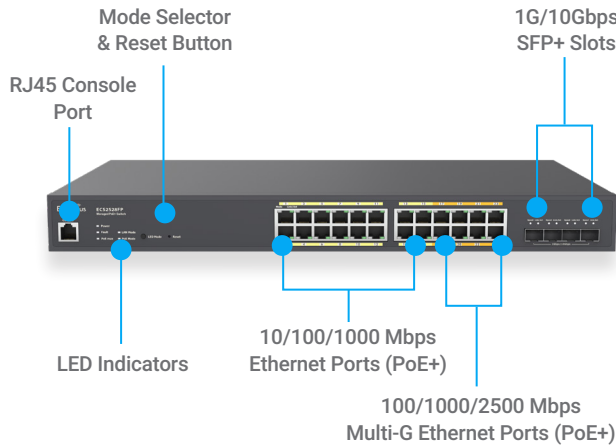

### ECS2552FP

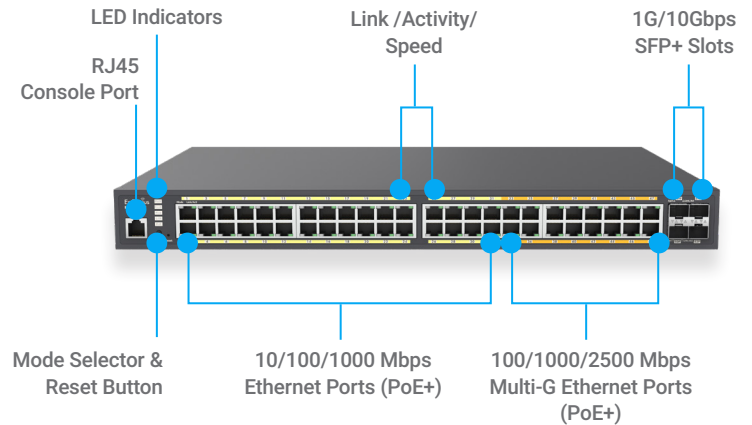

### ECS5512

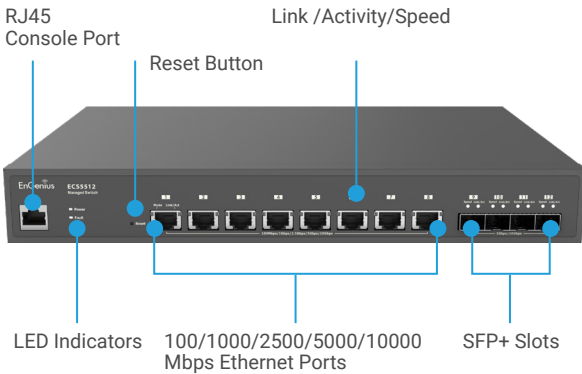

### ECS5512FP

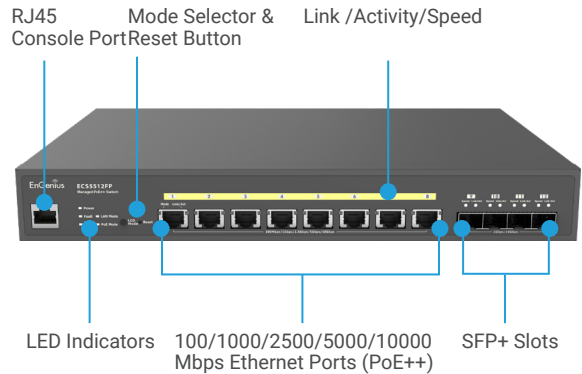

EnGenius Technologies | Costa Mesa, California, USA

Email: [partners@engeniustech.com](mailto:partners@engeniustech.com)  
Website: [www.engeniustech.com](http://www.engeniustech.com)  
Local contact: (+1) 714 432 8668

EnGenius Networks Singapore Pte Ltd. | Singapore

Email: [techsupport@engeniustech.com.sg](mailto:techsupport@engeniustech.com.sg)  
Website: [www.engeniustech.com.sg](http://www.engeniustech.com.sg)  
Local contact: (+65) 6227 1088

EnGenius Technologies Canada | Ontario, Canada

Email: [info@engeniustech.com](mailto:info@engeniustech.com)  
Website: [www.engeniustech.com](http://www.engeniustech.com)  
Local contact: (+1) 905 940 8181

EnGenius Networks Dubai | Dubai, UAE

Email: [support@engeniustech.com](mailto:support@engeniustech.com)  
Website: [www.engeniustech.com](http://www.engeniustech.com)  
Local contact: +971 4 339 1227

EnGenius Networks Europe B.V. | Eindhoven, Netherlands

Email: [sale@engeniustech.com](mailto:sale@engeniustech.com)  
Website: [www.engeniustech.com](http://www.engeniustech.com)  
Local contact: (+31) 40 8200 887

恩睿科技股份有限公司 | Taiwan, R.O.C.

Email: [sales@engeniustech.com.tw](mailto:sales@engeniustech.com.tw)  
Website: [www.engeniustech.com.tw](http://www.engeniustech.com.tw)  
Local contact: (+886) 2 2652 1808